



Changes for the Better

DESIGN REFERENCE FOR
ELEVATOR INSTALLATIONS

for a greener tomorrow 

Quality 
in Motion



NexWay

● Capacity and Speed *1

Rated capacity (kg)	Number of persons	Rated speed (m/sec)											EN81-1
		2.0	2.5	3.0	3.5	4.0	5.0	6.0	7.0	8.0	9.0	10.0	
750	10	●	●	●	●	●	●	●	○	○	○	○	☆
900	12	●	●	●	●	●	●	●	○	○	○	○	☆
1050	14	●	●	●	●	●	●	●	○	○	○	○	☆
1200	16	●	●	●	●	●	●	●	○	○	○	○	☆
1350	18	●	●	●	●	●	●	●	○	○	○	○	☆
1600	21	●	●	●	●	●	●	●	○	○	○	○	☆
1800	24	●	●	●	●	●	●	●	○	○	○	○	☆
2000	26	●	●	●	●	●	●	●	○	○	○	○	☆
2250	30	○	○	○	○	○	○	○	○	○	○		☆
2500	33	○	○	○	○	○							☆
3000	40	○	○	○	○	○							☆

Notes:

*1: The symbol ○ shown in the table indicates that a technical inquiry is required.

The symbol ● shown in the table indicates that a technical inquiry is required depending on conditions.

*2: Refer to page 5 to 12 for the hoistway and machine room layout plans for the models with specifications marked in gray (). For the layouts for models with other specifications, please consult our local agents.

● Specifications *1

Rated speed (m/sec)	2.0	2.5	3.0	3.5	4.0	5.0	6.0	7.0	8.0	9.0	10.0	
Maximum number of stops	64 Please consult our local agents.											
Maximum travel (m) *2	750kg	150 Please consult our local agents.										
	900kg	150 Please consult our local agents.										
	1050kg	150 250 Please consult our local agents.										
	1200kg	200 250 Please consult our local agents.										
	1350kg	200 250 Please consult our local agents.										
	1600kg	200 250 Please consult our local agents.										
	1800kg	200 250 Please consult our local agents.										
2000kg	250 Please consult our local agents.											
Minimum floor height (mm)	2500 *3											

Notes:

*1: Please consult our local agents if the maximum travel exceeds the values specified in the above table.

*2: For the rated capacity 2250kg to 3000kg, please consult our local agents for maximum travel.

*3: For some elevator specifications, the floor height (distance between floors) must be a minimum of 2500mm. Please consult our local agents if the floor height is less than "Entrance height HH + 700mm".

● Control, Door and Operation Systems

●: Applicable —: Not applicable

Number of elevators in a bank	Control system	Door system	Operation system			
			1-car selective collective (Standard)	2-car group control system (optional)	ΣAI-22 group control system (option)	ΣAI-2200C group control system (option)
1 car	VVVF control and Data Network System with multiple microprocessor modules (VFGH)	VVVF control with microprocessor, 2-panel center opening <CO> (Standard), 2-panel side opening <2S> (option), 4-panel center opening <2CO> (option)	● (1C-2BC)	—	—	—
2 cars			—	● (2C-2BC)	—	—
3 cars			—	—	● (3C-ΣAI-22)	● (3C-ΣAI-2200C)
4 cars			—	—	● (4C-ΣAI-22)	● (4C-ΣAI-2200C)
5 cars			—	—	—	● (5C-ΣAI-2200C)
6 cars			—	—	—	● (6C-ΣAI-2200C)
7 cars			—	—	—	● (7C-ΣAI-2200C)
8 cars			—	—	—	● (8C-ΣAI-2200C)

Selective collective (2BC)

The system consists of call buttons in the car, and a riser of up and down destination floor buttons installed at each elevator hall (single button at terminal floors), which connect electrically with microprocessors supervising floor selection and direction of travel. A car will respond to those car and hall calls that comply with its direction of service.

When there are no more calls registered for the car's direction of travel, the car's service direction is reversed.

ΣAI-22 & ΣAI-2200C Group Control Systems

The systems, which employ an intelligent expert system and fuzzy logic, are specially designed for group control of 3 to 8 elevators (as described above). Practical information required for group control is stored in the system's memory as a "Knowledge Database". Drawing from this database, various traffic conditions are monitored and analyzed applying IF-THEN decision rules to maximize the effectiveness of each elevator operation.

The systems perform assignments to the most-used locations, and thereby provide superb efficiency and service.

In addition to the above, ΣAI-2200C system performs optimal car allocation using Dynamic Rule-set Optimizer.

Elevator traffic reaches a peak when people employed in the building arrive for work in the morning, when they break for lunch at midday, and when they leave for home in the evening. Obviously, the elevators must be capable of handling the increased traffic during these peaks. And during actual business hours, the elevators must be able to respond promptly to serve the people who are on the move inside the building as well as those who arrive at or leave the building. So that the elevators best suited to the conditions and environment at hand can be selected, Mitsubishi Electric applies computer simulation, traffic computation, and other techniques based on its wealth of experience in this field to offer a wide range of elevator consulting services. Given below are reference data useful for general planning.

Selecting the Elevator Speed

The maximum number of floors served in a building serves as the criterion for selecting the speed at which the elevators should travel. To select elevators using the chart below, if the building has 23 floors, select elevators with a speed of 3.5m/sec or 4.0m/sec.

Note: The following chart shows the recommended elevator speed per maximum number of service floors. The best suited speed varies depending on the following factors:

- *Building usage;
- *Single-tenant building or multi-tenant building;
- *Floor heights;
- *Population in the building;
- *Number of elevators in the group; or
- *Capacity of the elevator.

Please consult our local agents for details.

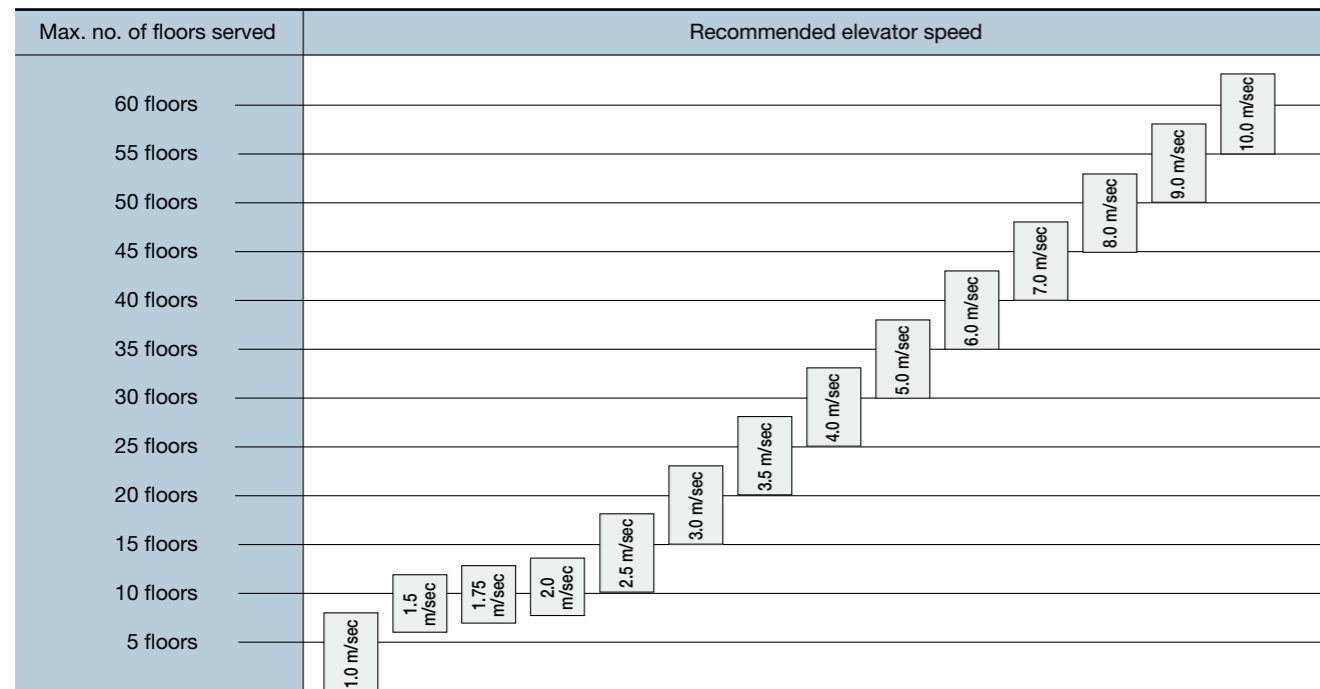

Selecting the Operation System

Scale of building	Large-scale office building							
	Medium-scale office building							
Number of elevators	1	2	3	4	5	6	7	8
Operation system								
1-car selective collective (2BC)	○							
2-car group control system (2BC)		○						
ΣAI-22 group control system			○					
ΣAI-2200C group control system				○	○	○	○	○

Applicable system ○ Recommended system

Notes on Installation Planning

Elevator Arrangement

- Elevator installations should be properly planned according to such factors as the size and nature or kind of the building, the traffic flow and peak traffic demand or conditions, the location of public transportation facilities and stores.
- Dispersing elevators in different areas of a building adversely affects their passenger-carrying efficiency. Therefore, elevators should, as far as possible, be concentrated in the center of the building.
- When two groups of elevators face each other, ample space should be left between the groups.
- The number of elevators in each group should be decided on the basis of the physical arrangement of the elevators and the floors served.
- As much as possible, all the floors served by one group of elevators should be functionally and structurally similar. Dissimilarity among the floors served will result in a drop in service level.
- In residential buildings, hotels, and the like, it is not desirable for the elevator hall to be located farther than 50 meters from any apartment or room.

Points Relating to the Hoistway

- In steel-reinforced concrete buildings, design the hoistways so that concrete walls are at least 120mm thick.
- Hoistways must be no more than 30mm out of plumb.
- No wiring or distribution panels should be built into or mounted on hoistway walls.
- It is forbidden under most building codes to install any conduit work or piping in hoistways except as required for the elevator itself.
- Pit-depth and overhead-height dimensions must always be at least the minimum shown in the drawings.
- If it proves necessary to make use of space below the pit, contact our local subcontractor.
- When the building is to be of steel construction, our local subcontractor should be brought into the discussion at the earliest possible moment.

Points Relating to the Machine Room

- Provide the recommended width and height to assure that there will be sufficient room for inspection and maintenance.
- Since the elevator drive equipment generates considerable heat, sufficient ventilation and or air-conditioning capacity must be provided to assure that the machine-room temperature does not exceed 40°C. Refer to elevator site requirements at page 18 for details.
- When occupied areas of the building are in close proximity to the machine room, such as in the case of elevators for the low and middle floors of a high-rise building, it may be desirable to provide additional soundproofing or intervening walls.

Some Examples of Bank Arrangements

Desirable Plans



Bank of 4 elevators, in-line arrangement.

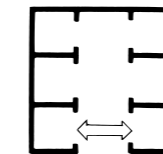

3.5 ~ 4.5m

Group of 6 elevators, alcove arrangement.

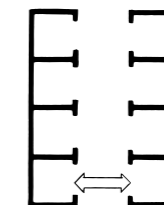

3.5 ~ 4.5m

Group of 8 elevators, facing arrangement. Plan the building traffic flow to minimize through-traffic in the elevator hall.

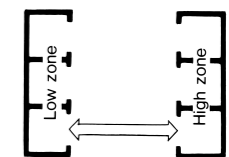

6m or more

Two banks, facing arrangement.

Undesirable Plans



Two banks, in-line arrangement. Inconvenient because of confusion as to the dividing point.

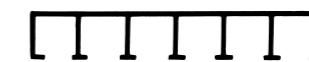

Bank of 6 elevators, in-line arrangement. Inconvenient because of increased walking distance and time.

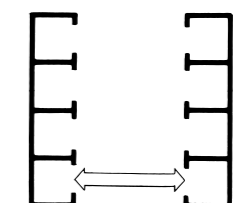

8 elevators in one bank set at too great a distance.

RATED SPEED OF 2.0~3.0 m/sec

Layout example of in-line arrangement

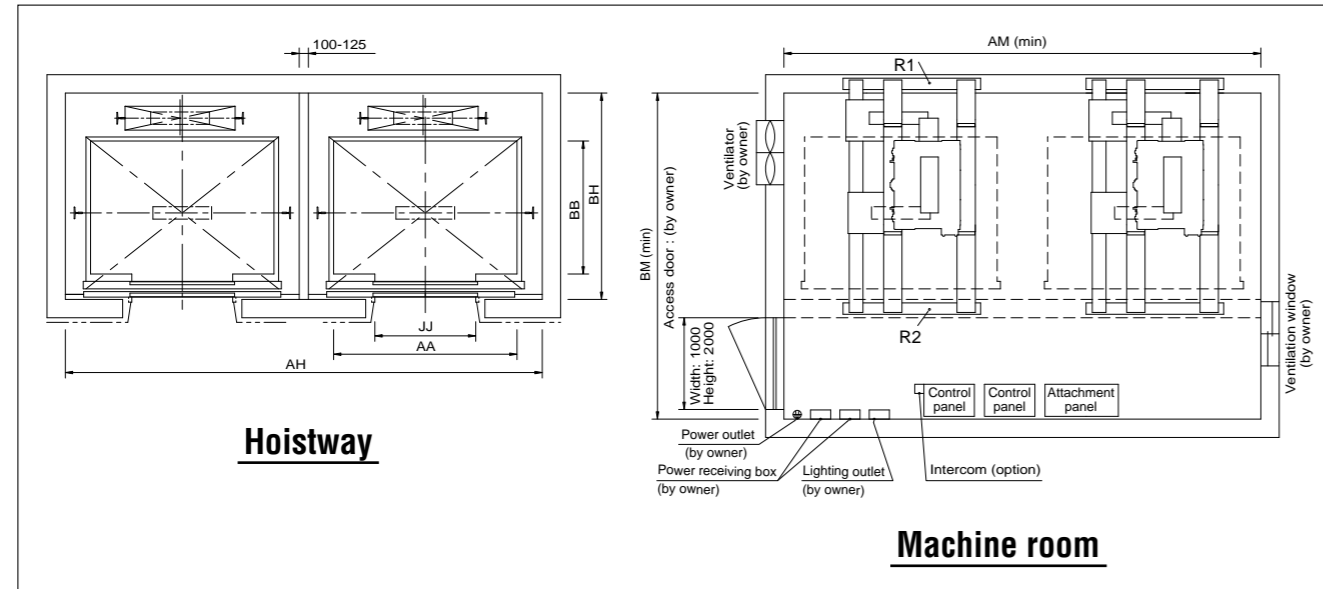

Dimension table of car, hoistway and machine room

Rated speed (m/sec)	Code number	Rated capacity (kg)	Number of persons	Entrance width JJ (mm)	Car internal dimensions (mm)	Internal dimensions of hoistway (mm) *1			Internal dimensions of machine room (mm)
						In-line arrangement			
						1-unit installation	2-unit installation	2-unit installation	
Width x Depth AA x BB	Width x Depth AH x BH	Width x Depth AH x BH	Width x Depth AM x BM						
2.0 2.5	P10	750	10	800	1400 x 1300	1900 x 2050	3900 x 2050	4500 x 3455	
	P12	900	12	900	1600 x 1300	2100 x 2050	4300 x 2050	4700 x 3455	
	P14	1050	14	900	1600 x 1500	2100 x 2250	4300 x 2250	4700 x 3655	
	P16	1200	16	1000	1800 x 1500	2300 x 2250	4700 x 2250	4900 x 3655	
	P18	1350	18	1100	2000 x 1500	2500 x 2250	5100 x 2250	5100 x 3655	
	P21	1600	21	1100	2000 x 1700	2500 x 2450	5100 x 2450	5100 x 3855	
	P24	1800	24	1100	2100 x 1750	2600 x 2550	5300 x 2550	5400 x 3955	
	P26	2000	26	1100	2100 x 1950	2600 x 2750	5300 x 2750	5400 x 4105	
3.0	P12	900	12	900	1600 x 1300	2100 x 2050	4300 x 2050	4700 x 3455	
	P14	1050	14	900	1600 x 1500	2100 x 2300	4300 x 2300	4700 x 3655	
	P16	1200	16	1000	1800 x 1500	2300 x 2300	4700 x 2300	4900 x 3655	
	P18	1350	18	1100	2000 x 1500	2500 x 2300	5100 x 2300	5100 x 3655	
	P21	1600	21	1100	2000 x 1700	2500 x 2500	5100 x 2500	5100 x 3855	
	P24	1800	24	1100	2100 x 1750	2600 x 2550	5300 x 2550	5400 x 3955	
P26	2000	26	1100	2100 x 1950	2600 x 2750	5300 x 2750	5400 x 4105		

- ★ All the above dimensions are calculated based on EN81-1 (1998).
- ★ The dimensions shown are minimum requirements, particularly in the figures of TC, OH and PD. Necessary tolerance should be separately considered for the building construction errors.
- ★ The dimensions TC, OH, PD and reaction load are calculated according to car and hoistway dimensions on the above table and conditions.

Note:
*1: The dimensions PD, OH and BH are calculated when the counterweight without safety gear is located in back of the car.

Reaction loads in machine room and pit (Unit: kN)

Rated speed (m/sec)		Rated capacity (kg)							
		750	900	1050	1200	1350	1600	1800	2000
2.0 2.5	R1	94	94	123	112	149	156	174	200
	R2	63	63	82	74	100	104	116	134
	P1	129	137	178	159	191	195	227	246
	P2	121	124	164	142	182	181	196	227
3.0	R1	-	106	157	158	160	161	191	193
	R2	-	70	105	106	106	107	127	129
	P1	-	149	205	191	196	214	245	245
	P2	-	138	200	185	182	189	215	215

Pit-depth (PD) *1 (Unit: mm)

Rated speed (m/sec)	Travel TR (m)	Rated capacity (kg)							
		750	900	1050	1200	1350	1600	1800	2000
2.0	TR ≤ 100	2080							
	100 < TR ≤ 150	2800							
	150 < TR ≤ 200	3050							
	200 < TR ≤ 250	3150							
2.5	TR ≤ 100	2080							
	100 < TR ≤ 150	2840							
	150 < TR ≤ 200	3200							
	200 < TR ≤ 250	3300							
3.0	TR ≤ 100	2650							
	100 < TR ≤ 150	3330							
	150 < TR ≤ 200	3500							
	200 < TR ≤ 250	3600							

Top clearance (TC) (Unit: mm)

Rated speed (m/sec)	Travel (TR) (m)	
	TR ≤ 100	100 < TR ≤ 250
2.0	1760	1910
2.5	1840	1990
3.0	2190	2340

Machine-room height (HM) (Unit: mm)

Rated speed (m/sec)	Regulation	
	EN81-1	
2.0	2500	
2.5	2500	
3.0	2500	

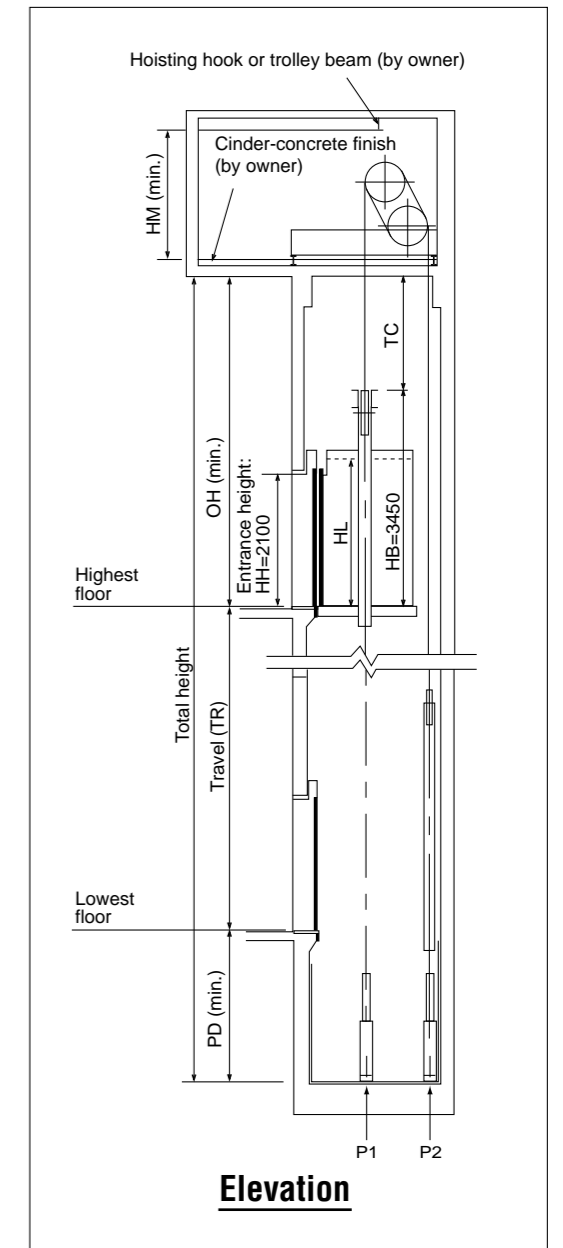

Overhead-height (OH) *1 (Unit: mm)

Rated speed (m/sec)	Travel TR (m)	Rated capacity (kg)							
		750	900	1050	1200	1350	1600	1800	2000
2.0	TR ≤ 100	5210							
	100 < TR ≤ 150	5360							
	150 < TR ≤ 200	5360							
	200 < TR ≤ 250	5360							
2.5	TR ≤ 100	5290							
	100 < TR ≤ 150	5440							
	150 < TR ≤ 200	5440							
	200 < TR ≤ 250	5440							
3.0	TR ≤ 100	5640							
	100 < TR ≤ 150	5790							
	150 < TR ≤ 250	5790							

Note: The dimensions OH are calculated when the car frame height (HB) is 3450mm.

RATED SPEED OF 3.5, 4.0 m/sec

Layout example of facing arrangement

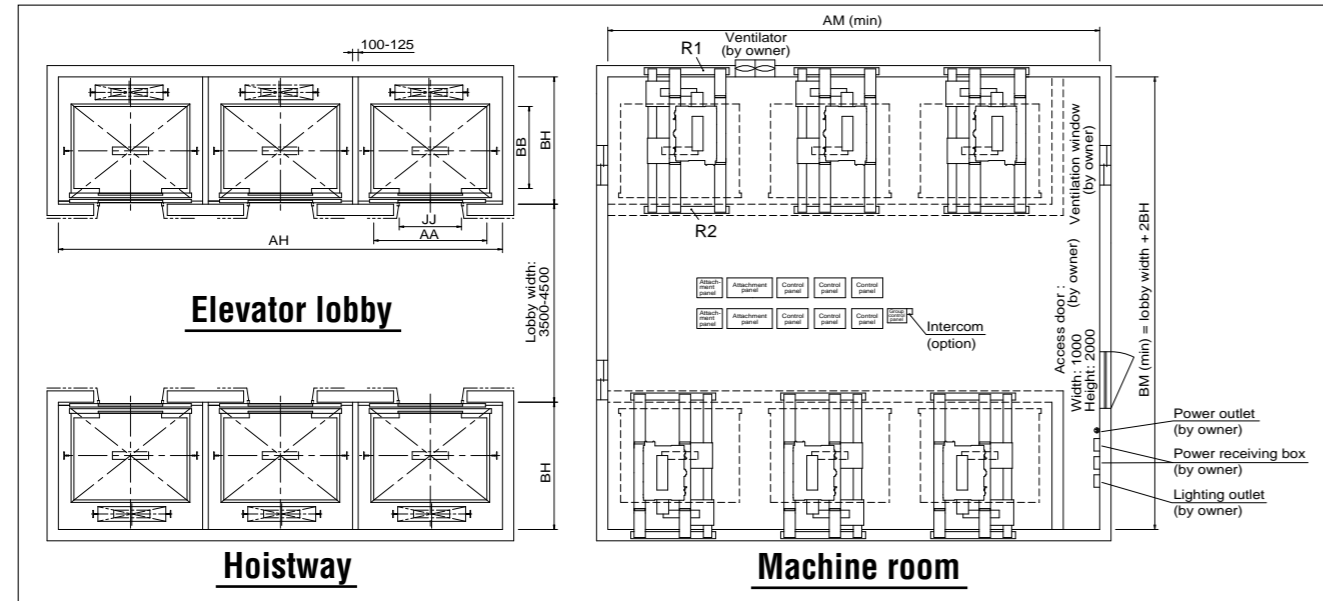

Reaction loads in machine room and pit (Unit: kN)

Rated speed (m/sec)	Rated capacity (kg)							
	750	900	1050	1200	1350	1600 ^{*2}	1800	2000
3.5	R1	106	157	158	160	161	191	193
	R2	70	105	106	106	107	127	129
	P1	149	205	196	196	214	245	245
	P2	138	200	185	182	189	215	215
4.0	R1	158	159	159	162	188	191	193
	R2	105	106	106	108	125	127	129
	P1	204	194	194	214	241	245	249
	P2	199	185	182	190	215	215	215

Pit-depth (PD) *1 (Unit: mm)

Rated speed (m/sec)	Travel TR (m)	Rated capacity (kg)							
		750	900	1050	1200	1350	1600	1800	2000
3.5	TR ≤ 100	3020							
	100 < TR ≤ 150	3370							
	150 < TR ≤ 200	3660							
	200 < TR ≤ 250	3760							
4.0	TR ≤ 200	3920							
	200 < TR ≤ 250	4020							

Dimension table of car, hoistway and machine room

Rated speed (m/sec)	Code number	Rated capacity (kg)	Number of persons	Entrance width JJ (mm)	Car internal dimensions (mm)	Internal dimensions of hoistway (mm) *1	
						In-line arrangement	
						2-unit installation	2-unit installation
						Width × Depth AA × BB	Width × Depth AH × BH
3.5	P12	900	12	900	1600 × 1300	4400 × 2100	4750 × 3455
3.5 4.0	P14	1050	14	900	1600 × 1500	4400 × 2300	4750 × 3655
	P16	1200	16	1000	1800 × 1500	4800 × 2300	4950 × 3655
	P18	1350	18	1100	2000 × 1500	5200 × 2300	5200 × 3655
	P21	1600	21	1100	2000 × 1700	5200 × 2500	5200 × 3855 ^{*3}
	P24	1800	24	1100	2100 × 1750	5400 × 2550	5400 × 3955
	P26	2000	26	1100	2100 × 1950	5400 × 2750	5400 × 4105

- ★ All the above dimensions are calculated based on EN81-1 (1998).
- ★ The dimensions shown are minimum requirements, particularly in the figures of TC, OH and PD. Necessary tolerance should be separately considered for the building construction errors.
- ★ The dimensions TC, OH, PD and reaction load are calculated according to car and hoistway dimensions on the above table and conditions.

Notes:

- *1: The dimensions PD, OH and BH are calculated when the counterweight without safety gear is located in back of the car.
- *2: Traction machine for the rated capacity 1600kg differs depending on the car weight.
- *3: AM × BM is 5300 × 3855 only when the rated speed is 4.0m/sec and traction machine type is PML-F50.

Top clearance (TC) (Unit: mm)

Rated speed (m/sec)	Travel (TR) (m)		
	TR ≤ 100	100 < TR ≤ 150	150 < TR ≤ 250
3.5	2520	2670	
4.0	3070		

Machine-room height (HM) (Unit: mm)

Rated speed (m/sec)	Regulation	
	EN81-1	
3.5	2500	
4.0	2500	

Overhead-height (OH) *1 (Unit: mm)

Rated speed (m/sec)	Travel TR (m)	Rated capacity (kg)							
		750	900	1050	1200	1350	1600	1800	2000
3.5	TR ≤ 100	5970							
	100 < TR ≤ 150	6120							
	150 < TR ≤ 200	6120							
	200 < TR ≤ 250	6520							

Note: The dimensions OH are calculated when the car frame height (HB) is 3450mm.

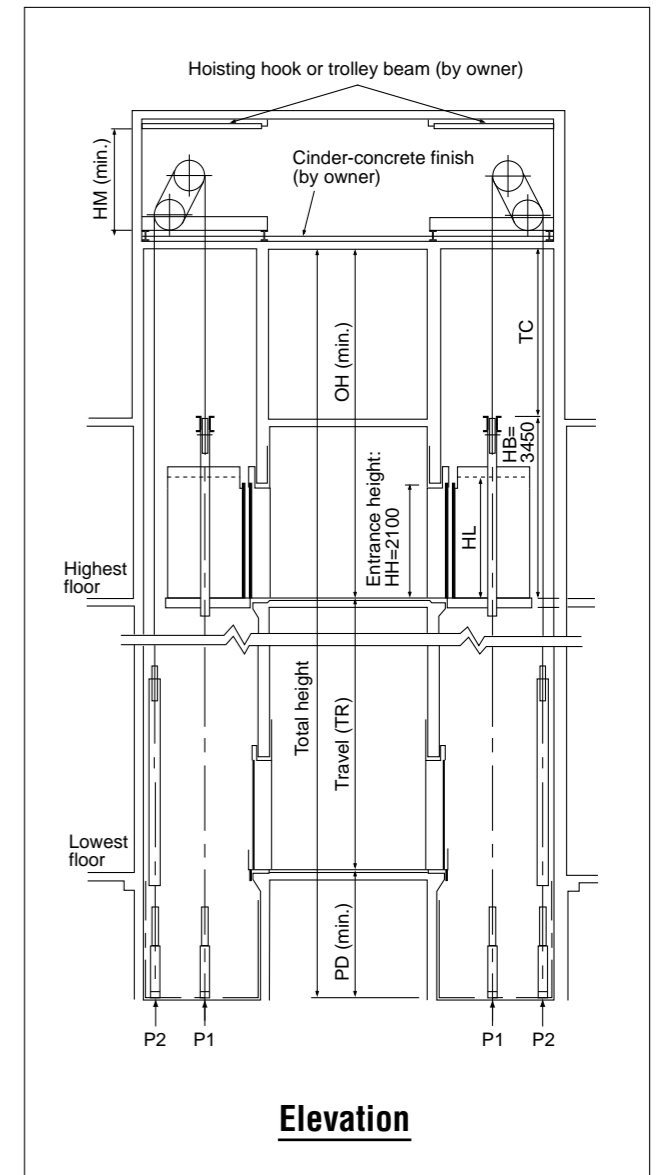

Layout example of facing arrangement

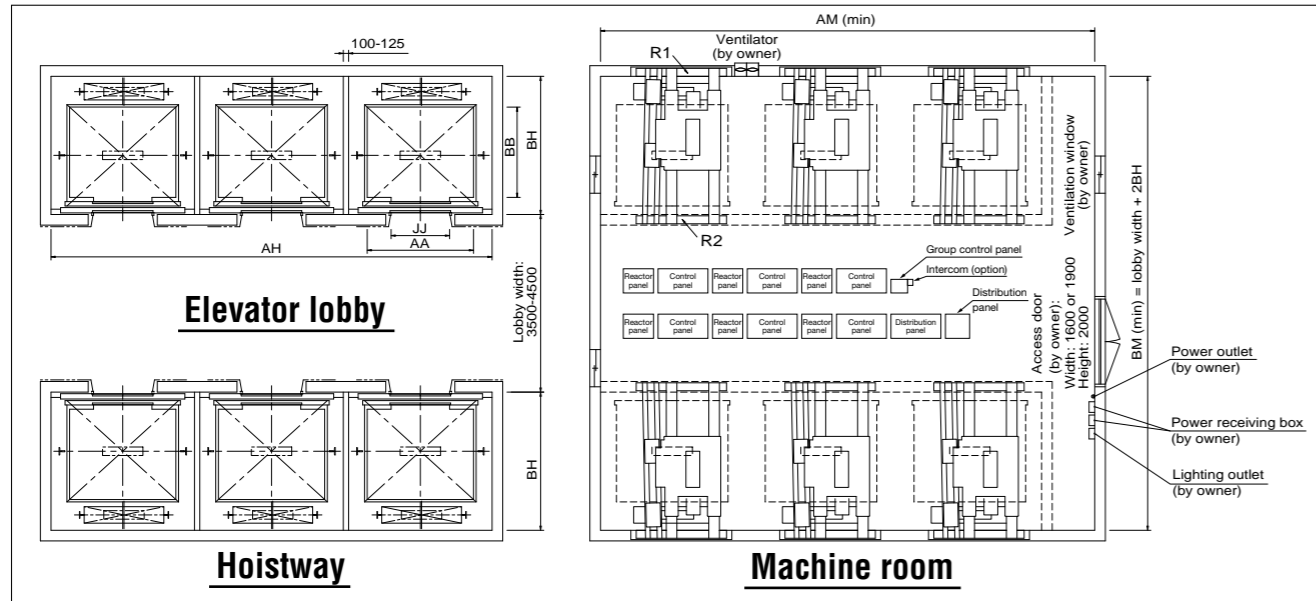

Reaction loads in machine room and pit (Unit: kN)

Rated speed (m/sec)		Rated capacity (kg)				
		1200	1350	1600	1800	2000
5.0	R1	165	175	185	195	195
	R2	110	120	125	130	130
	P1	215	215	225	240	240
	P2	205	210	205	220	220

Pit-depth (PD) dimensions (Unit: mm)

Rated speed (m/sec)	Travel TR (m)	Rated capacity (kg)				
		1200	1350	1600	1800	2000
5.0	TR ≤ 150	4050				
	150 < TR ≤ 200	4350				
	200 < TR ≤ 250	4450				

Dimension table of car, hoistway and machine room

Rated speed (m/sec)	Code number	Rated capacity (kg)	Number of persons	Entrance width JJ (mm)	Car internal dimensions (mm)	Internal dimensions of hoistway (mm) ^{*1}	
						In-line arrangement	
						2-unit installation	2-unit installation
						Width × Depth AA × BB	Width × Depth AH × BH
						Width × Depth AM × BM	
5.0	P16	1200	16	1000	1800 × 1450	5100 × 2300	5300 × 4000
	P18	1350	18	1100	2000 × 1450	5500 × 2300	5500 × 4000
	P21	1600	21	1100	2000 × 1700	5500 × 2550	5500 × 4250
	P24	1800	24	1100	2100 × 1750	5700 × 2650	5700 × 4300
	P26	2000	26	1100	2100 × 1950	5700 × 2850	5700 × 4450

- ★ All the above dimensions are calculated based on EN81-1 (1998).
- ★ The dimensions shown are minimum requirements, particularly in the figures of TC, OH and PD. Necessary tolerance should be separately considered for the building construction errors.
- ★ TC, OH, PD and reaction load are calculated according to car and hoistway dimensions on the above table. (When the counterweight is back drop.)
- ★ The shaft independently housing a single car is not recommended because noise increases. Please consult our local agents if the shaft of that kind is required.

Note:
*1: The dimensions BH are calculated when the counterweight is equipped without safety gear.

Top clearance (TC) dimensions (Unit: mm)

Rated speed (m/sec)	Travel (TR) (m)	
	TR ≤ 150	150 < TR ≤ 250
5.0	3200	3600

Machine-room height (HM) (Unit: mm)

Rated speed (m/sec)	Travel (TR) (m)	Rated capacity (kg)				
		1200	1350	1600	1800	2000
5.0	TR ≤ 150	2300				
	150 < TR ≤ 250	2300		2800		

Overhead-height (OH) dimensions (Unit: mm)

Rated speed (m/sec)	Travel TR (m)	Rated capacity (kg)				
		1200	1350	1600	1800	2000
5.0	TR ≤ 150	6650				
	150 < TR ≤ 250	7050				

Note: The dimensions OH are calculated when the car frame height (HB) is 3450mm.

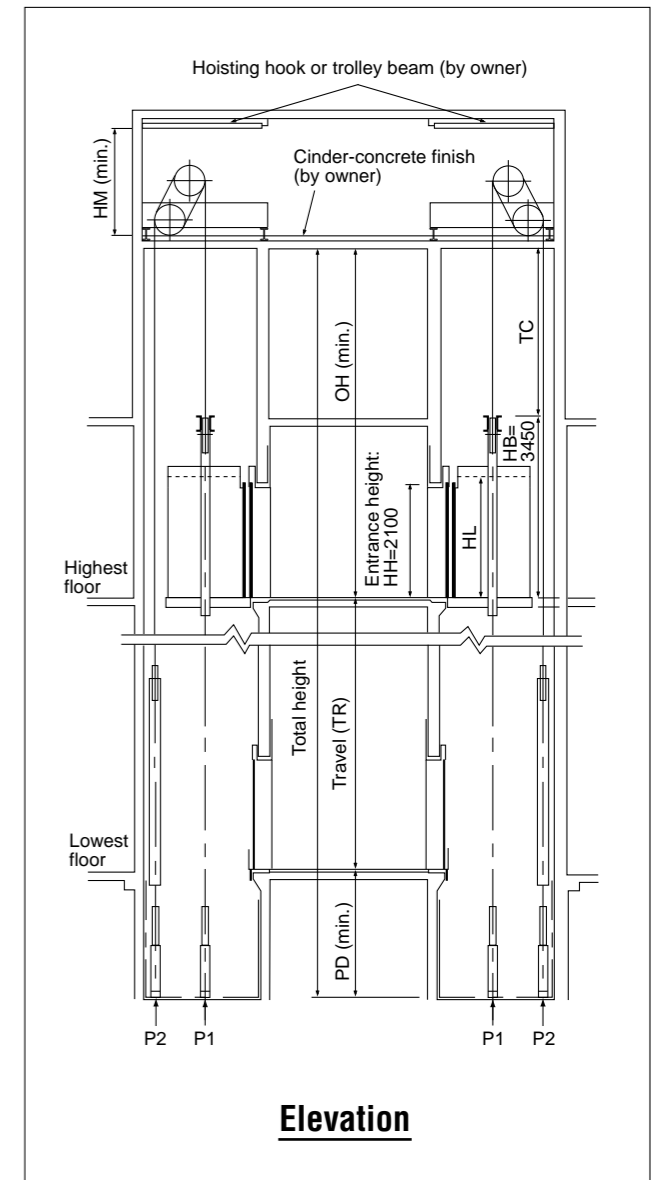

Layout example of facing arrangement

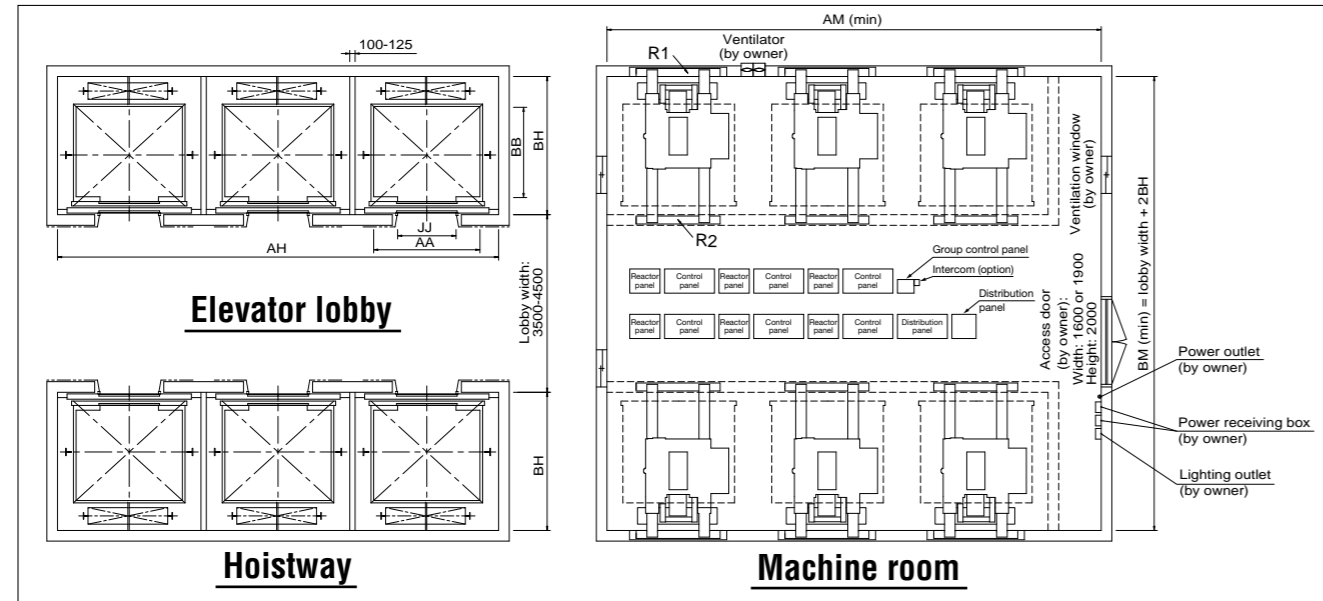

Reaction loads in machine room and pit (Unit: kN)

Rated speed (m/sec)		Rated capacity (kg)				
		1200	1350	1600	1800	2000
6.0	R1	170	170	185	195	195
	R2	115	115	125	130	130
	P1	215	215	230	240	240
	P2	210	205	215	220	220

Pit-depth (PD) dimensions (Unit: mm)

Rated speed (m/sec)	Travel TR (m)	Rated capacity (kg)				
		1200	1350	1600	1800	2000
6.0	TR ≤ 150	4050				
	150 < TR ≤ 200	4350				
	200 < TR ≤ 250	4450				

Dimension table of car, hoistway and machine room

Rated speed (m/sec)	Code number	Rated capacity (kg)	Number of persons	Entrance width JJ (mm)	Car internal dimensions (mm)	Internal dimensions of hoistway (mm) *1	
						In-line arrangement	
						2-unit installation	2-unit installation
					Width × Depth AA × BB	Width × Depth AH × BH	Width × Depth AM × BM
6.0	P16	1200	16	1000	1800 × 1450	5100 × 2300	5250 × 4000
	P18	1350	18	1100	2000 × 1450	5500 × 2300	5550 × 4000
	P21	1600	21	1100	2000 × 1700	5500 × 2600	5550 × 4250
	P24	1800	24	1100	2100 × 1750	5700 × 2650	5700 × 4300
	P26	2000	26	1100	2100 × 1950	5700 × 2850	5700 × 4450

- ★ All the above dimensions are calculated based on EN81-1 (1998).
- ★ The dimensions shown are minimum requirements, particularly in the figures of TC, OH and PD. Necessary tolerance should be separately considered for the building construction errors.
- ★ TC, OH, PD and reaction load are calculated according to car and hoistway dimensions on the above table. (When the counterweight is back drop.)
- ★ The shaft independently housing a single car is not recommended because noise increases. Please consult our local agents if the shaft of that kind is required.

Note:
*1: The dimensions BH are calculated when the counterweight is equipped without safety gear.

Top clearance (TC) dimensions (Unit: mm)

Rated speed (m/sec)	Travel (TR) (m)	
	TR ≤ 150	150 < TR ≤ 250
6.0	3200	3600

Machine-room height (HM) (Unit: mm)

Rated speed (m/sec)	Travel (TR) (m)	Rated capacity (kg)				
		1200	1350	1600	1800	2000
6.0	TR ≤ 150	2300				
	150 < TR ≤ 250	2300		2800		

Overhead-height (OH) dimensions (Unit: mm)

Rated speed (m/sec)	Travel TR (m)	Rated capacity (kg)				
		1200	1350	1600	1800	2000
6.0	TR ≤ 150	6650				
	150 < TR ≤ 250	7050				

Note: The dimensions OH are calculated when the car frame height (HB) is 3450mm.

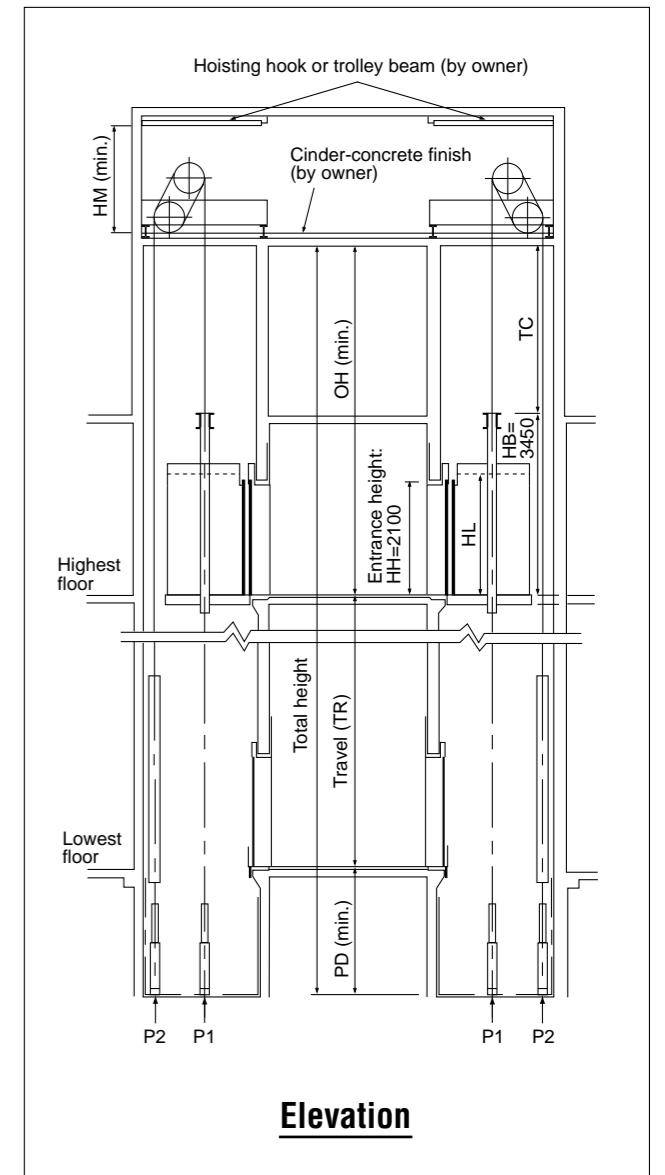

Type E-102 (standard)

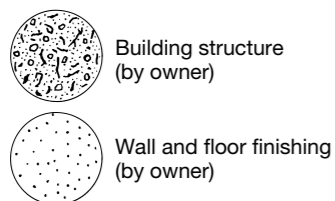
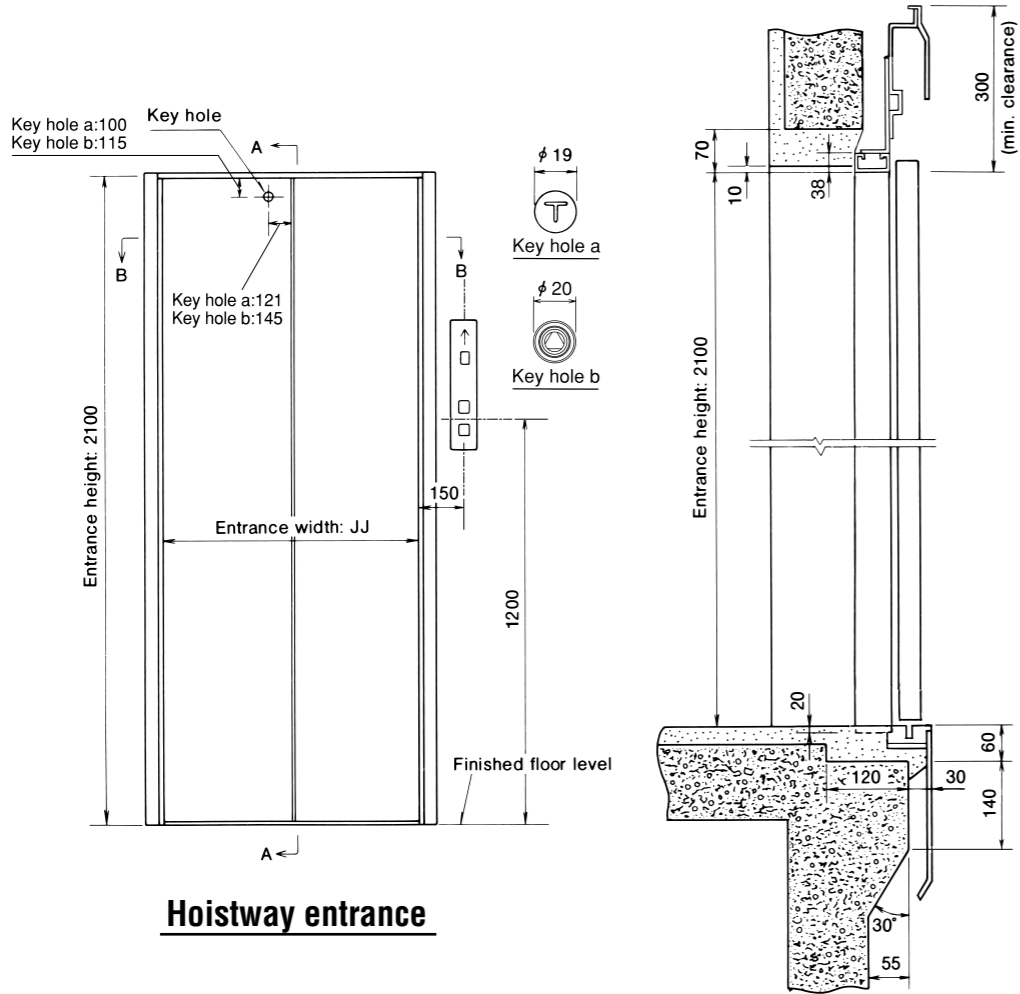
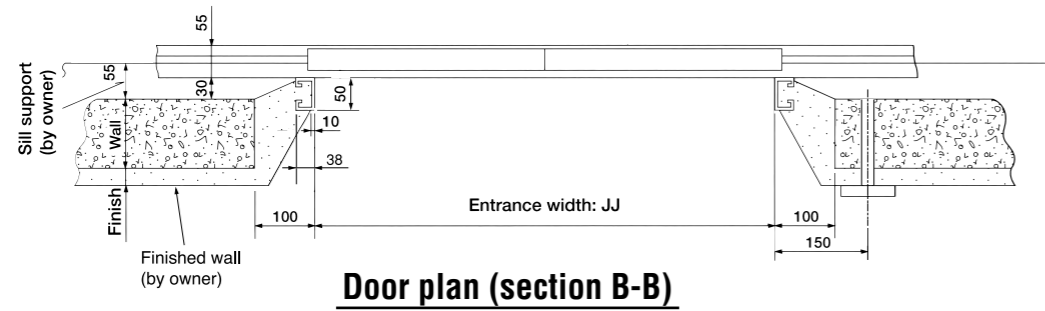

Note: 1. Triangular key-hole is required under EN81-1.
2. Details in sections A-A and B-B are not for BS-476 fire rated doors.

Type E-302, E-312 (option)

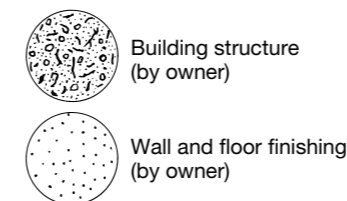
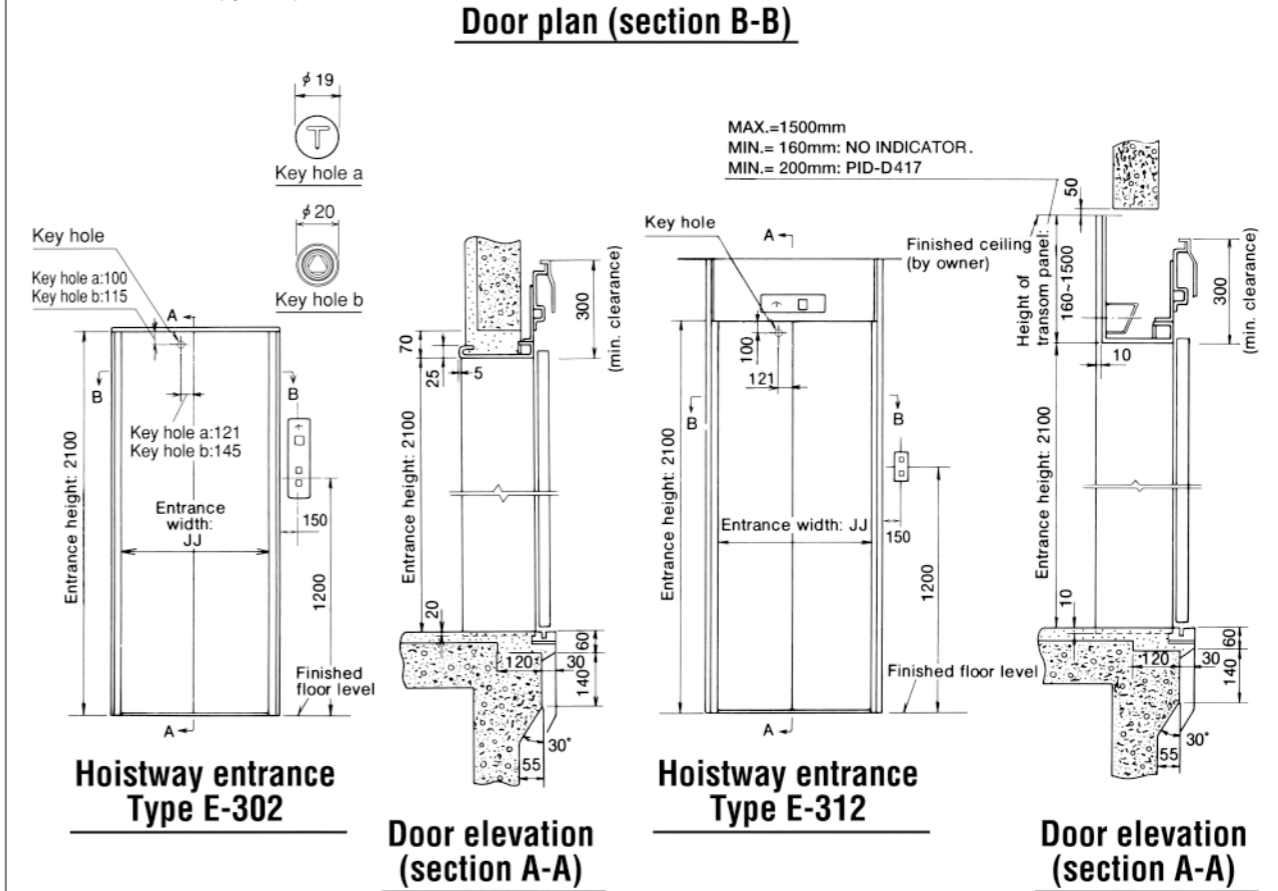
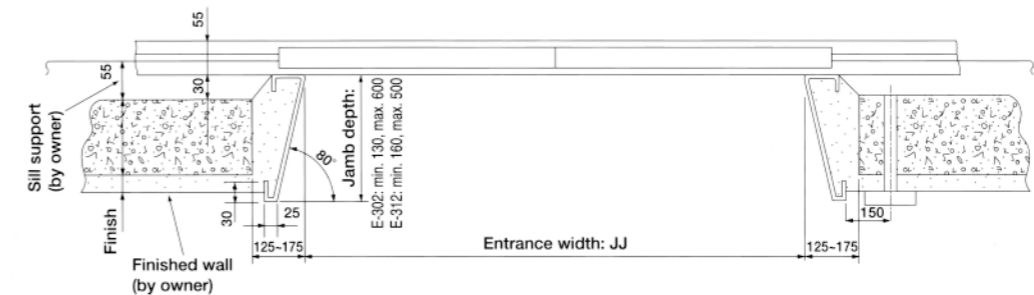

Note: 1. Triangular key-hole is required under EN81-1.
2. Details in sections A-A and B-B are not for BS-476 fire rated doors.

● Power Feeder Data *1

Speed (m/sec)	Rated load (kg)	Traction motor (kW)	Current at 400V *2		Capacity of power supply (kVA)	NF in M/R at 400V system (A)	Heat emission (W)
			FLU (A)	FLAcc (A)			
2.0	750	15	27	52	16	75	2330
	900	15	31	56	18	75	2800
	1050	15	33	61	19	75	3260
	1200	20	37	67	21	75	3730
	1350	20	41	72	23	75	4190
	1600	20	47	82	26	75	4970
	1800	23	57	98	31	100	5600
	2000	28	59	107	33	100	6210
2.5	750	18	31	64	18	75	2910
	900	18	36	69	20	75	3490
	1050	18	39	75	21	75	4070
	1200	25	44	82	23	75	4660
	1350	25	48	88	25	75	5240
	1600	25	56	100	29	100	6210
	1800	28	67	121	34	100	7000
	2000	35	70	134	37	100	7800
3.0	750	22	34	74	19	75	3490
	900	22	39	81	21	75	4190
	1050	22	45	90	23	75	4890
	1200	30	50	98	25	100	5590
	1350	30	56	105	28	100	6280
	1600	30	65	119	32	100	7450
	1800	34	76	143	40	125	8400
	2000	42	81	163	42	125	9400
3.5	750	25	40	97	21	75	4070
	900	25	44	99	23	75	4890
	1050	25	51	113	27	100	5700
	1200	35	57	124	30	100	6520
	1350	35	63	131	33	100	7330
	1600	35	74	144	37	125	8690
	1800	39	92	174	46	125	9800
	2000	49	94	197	47	150	10860
4.0	750	29	44	110	23	75	4660
	900	29	49	112	26	100	5590
	1050	29	57	123	30	100	6520
	1200	40	64	135	33	125	7450
	1350	40	71	143	36	125	8380
	1600	40	83	165	41	150	9930
	1800	45	102	196	49	150	11200
	2000	56	104	231	51	150	12410
5.0	1200	42	80	196	41	125	9400
	1350	42	88	211	44	125	10500
	1600	50	103	238	50	150	12500
	1800	53	114	253	57	175	14000
	2000	58	126	274	62	200	15600
6.0	1200	56	92	237	46	150	11200
	1350	56	102	252	50	150	12600
	1600	56	120	284	59	175	14900
	1800	63	133	304	65	200	16800
	2000	70	147	328	72	225	18700

FLU: current during upward operation with full load at power supply voltage of 400V.
FLAcc: current while accelerating with full load at power supply voltage of 400V.

Notes:

*1: The values in the table above are for the case where power supply voltage is 400V. If the power supply voltage is within the range of 380 to 440V (except for 400V), calculate values by referring to page 16. If the power supply voltage is not within the range of 380 to 440V, please consult our local agents.

*2: If power supply voltage (E) is a value other than 400V, FLU current and FLAcc current are obtained via the following formula.
(FLU/FLAcc current (A) at E (V)) = (Current at 400V) × (400/E (V))

Table 1

Feeder size (mm ²)	Coefficient
3.5	5.1
5.5	8.0
8	11.6
14	20.6
22	32.1
30	42.5
38	54.3
50	70.7
60	87.3
80	115
100	148
125	184
150	225
200	287
250	371
325	473

Table 2

No. of elevators on common feeder	Diversity factor		
	For FLU	For FLAcc	
		Without express zone	With express zone
2	2.0	1.7	1.85
3	2.7	2.4	2.7
4	3.1	2.95	3.4
5	3.25	3.6	4.2
6	3.3	4.1	4.9
7	3.71	4.6	5.6
8	4.08	5.1	6.3
9	4.45	5.6	6.9
10	4.8	6.0	7.6

Feeder Size Calculation

- The feeder must be able to withstand continuous flow of the following current at an ambient temperature of 40°C.

$$1.25 \times \text{FLU (A)} \dots \text{FLU} \leq 50 \text{ (A)}$$

$$1.10 \times \text{FLU (A)} \dots \text{FLU} > 50 \text{ (A)}$$

(FLU (A): current during upward operation with full load at power supply voltage of 400V.)

The wire length for the feeder size must be calculated via the following formula.

$$\text{Wire length (m)} \leq \text{Coefficient}^* \times E \text{ (V)} / \text{FLAcc (A)}$$

(E: power supply voltage (V))

(FLAcc (A): current while accelerating with full load at power supply voltage of 400V)

*Refer to the table 1 for coefficients.

- When power is supplied to multiple elevators in a group through a common feeder, the capacity of the power supply transformer, the size of the feeder, and the current rating of the no-fuse (NF) breaker for one elevator are each multiplied by the corresponding diversity factor at table 2.

● Electrical Equipment Required for Elevator Operation

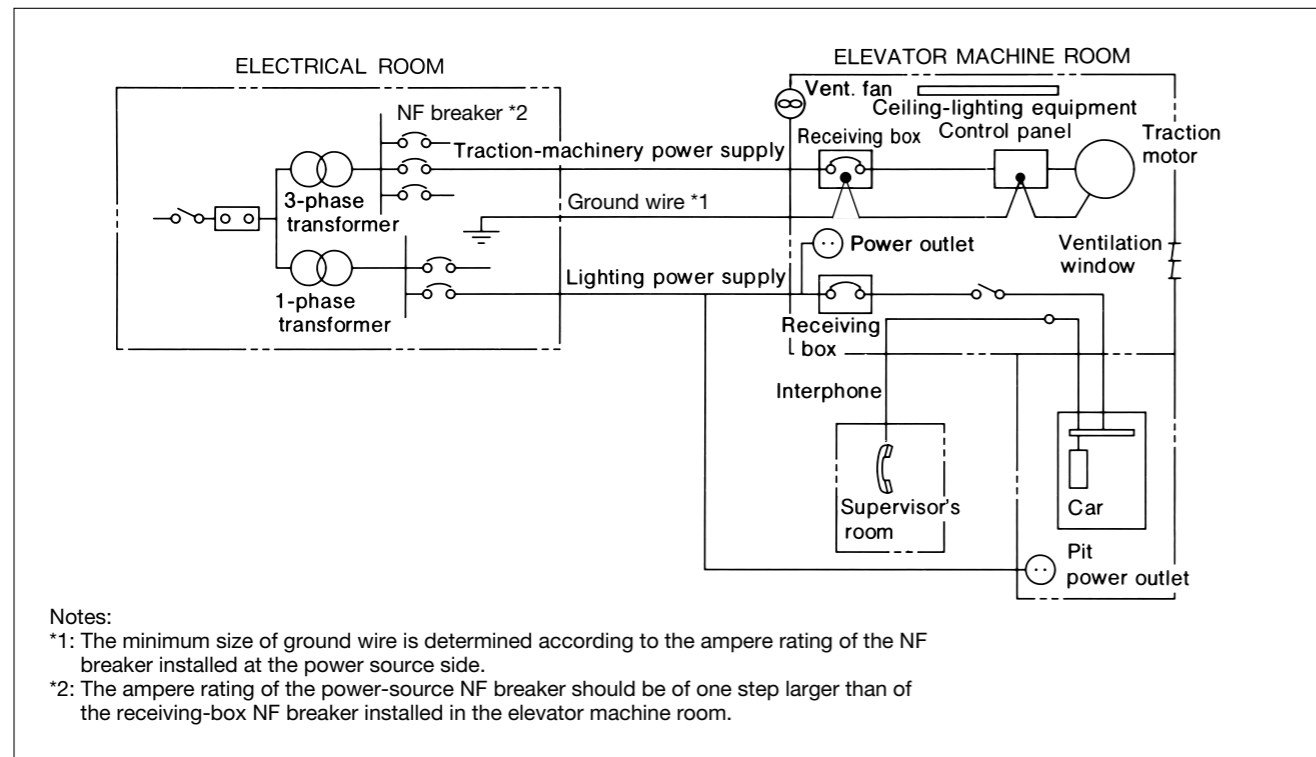

Traction-Machinery Power Supply

It is necessary to install power-supply equipment of sufficient capacity to ensure the elevators accelerating smoothly and landing accurately.

The power supply should be kept within a voltage-fluctuation range of +5 ~ -10%, and a voltage-imbalance factor of 5%.

When selecting protective breakers on the power-supply side, be guided by voltage ratings of the no-fuse breakers supplied with the elevators.

Power Supply for Lighting

Lighting for the elevator cars and indicators, where possible, should be supplied via a separate circuit that will not be affected by power failures elsewhere.

Ventilation Equipment

A machine-room ventilation device having a sufficient capacity to keep the room temperature below 40°C is required.

A ventilation window should also be installed at the opposite side of ventilation fan.

Intercom (where necessary)

This is essential to establish the communication between elevator passengers and outside in case of emergency.

The master station transceiver is usually in a location readily accessible to the supervisor, in the central supervisor's room or elevator lobby. The wiring work between the master station and the elevator machine room is not included in the elevator contract.

To facilitate piping and wiring, it is desirable to decide on the position of the master station at the earliest stage of building design.

Lighting Equipment

The machine room should be fitted with good lighting for maintenance work. The light switch should be positioned close to the machine-room entrance.

Inspection Power Outlets

These should be installed in the machine room and pit for use during inspection and maintenance.

Work Not Included in Elevator Contract

The following items are excluded from Mitsubishi Electric's elevator installation work, and are therefore the responsibility of the building owner or general contractor:

- Construction of the elevator machine room with proper beams and slabs, equipped with a lock, complete with illumination, ventilation and waterproofing.
- Access to the elevator machine room sufficient to allow passage of the control panel and traction machine.
- Architectural finishing of the machine room floor, and the walls and floors in the vicinity of the entrance hall after installation has been completed.
- Construction of an illuminated, ventilated and waterproofed elevator hoistway.
- A ladder to the elevator pit.
- The provision of cutting the necessary openings and joists.
- Separate beams, when the hoistway dimensions markedly exceed the specifications, and intermediate beams when two or more elevators are installed.
- All other work related to building construction.
- The machine room power-receiving panel and the electrical wiring for illumination, plus the electrical wiring from the electrical room to the power-receiving panel.
- The laying of conduits and wiring between the elevator pit and the terminating point for the devices installed outside the hoistway, such as the emergency bell, intercom, monitoring and security devices, etc.
- The power consumed in installation work and test operations.
- All the necessary building materials for grouting in of brackets, bolts, etc.
- The test provision and subsequent alteration as required, and eventual removal of the scaffolding as required by the elevator contractor, and any other protection of the work as may be required during the process.
- The provision of a suitable, locked space for the storage of elevator equipment and tools during elevator installation.
- The security system, such as a card reader, connected to Mitsubishi Electric's elevator controller, when supplied by the building owner or general contractor.

* Work responsibilities in installation and construction shall be determined according to local laws. Please consult our local agents for details.

Elevator Site Requirements

- The temperature of the machine room and elevator hoistway shall be below 40°C.
- The following conditions are required for maintaining elevator performance.
 - a. The relative humidity shall be below 90% on a monthly average and below 95% on a daily average.
 - b. The machine room and the elevator hoistway shall be finished with mortar or other materials so as to prevent concrete dust.
 - c. Prevention shall be provided against icing and condensation occurring due to a rapid drop in the temperature in the machine room and elevator hoistway.
- Voltage fluctuation shall be within a range of +5% to -10%.

Ordering Information

Please include the following information when ordering or requesting estimates:

- The desired number of units, speed and loading capacity.
- The number of stops or number of floors to be served.
- The total elevator travel and each floor-to-floor height.
- Operation system.
- Selected design and size of car.
- Entrance design.
- Signal equipment.
- A sketch of the part of the building where the elevators are to be installed.
- The voltage, number of phases, and frequency of the power source for the motor and lighting.

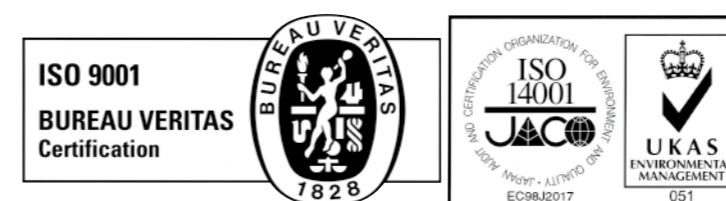

Mitsubishi Elevator Inazawa Works has acquired ISO 9001 certification by the International Standards Organization (ISO) based on a review of quality management. The company has also acquired environmental management system standard ISO 14001 certification.



for a greener tomorrow

Eco Changes is the Mitsubishi Electric Group's environmental statement, and expresses the Group's stance on environmental management. Through a wide range of businesses, we are helping contribute to the realization of a sustainable society.

mitsubishi electric corporation
HEAD OFFICE : TOKYO BLDG., 2-7-3, MARUNOUCHI, CHIYODA-KU, TOKYO 100-8310, JAPAN

Visit our website at:
<http://www.mitsubishielectric.com/elevator/>

 **Safety Tips:** Be sure to read the instruction manual fully before using this product.

New publication effective Mar. 2014.
Specifications are subject to change without notice.

©2014 Mitsubishi Electric Corporation